

مثال: گره های انتهای اعضا را به دست آورید.

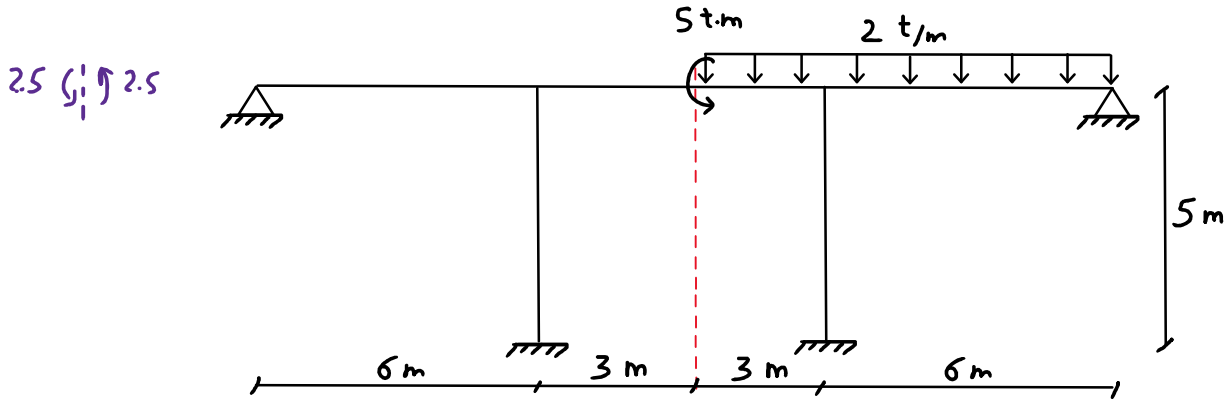

2.5 (↑) 2.5

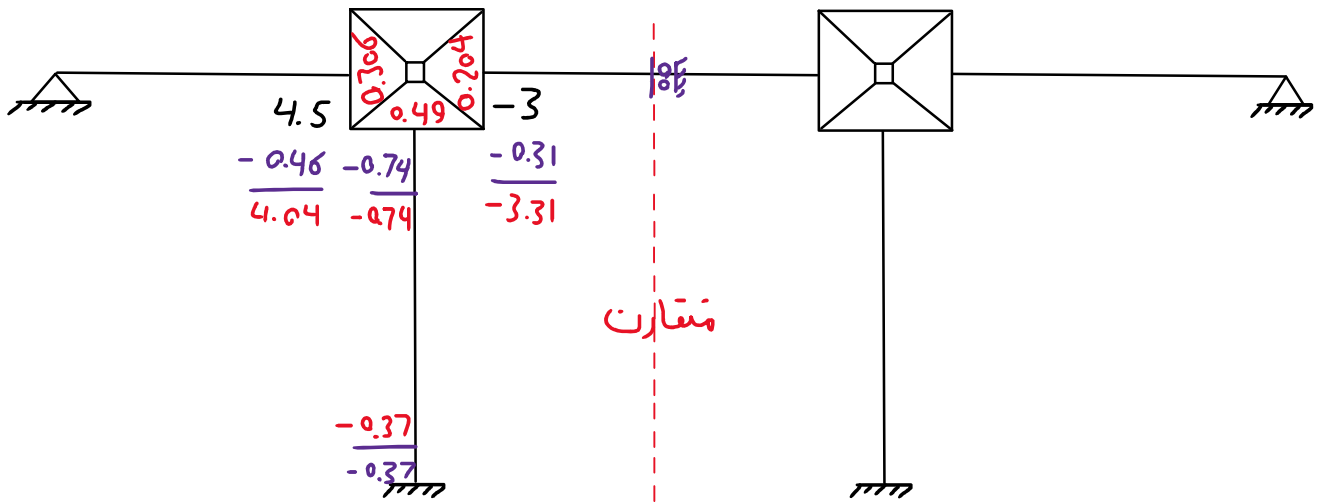
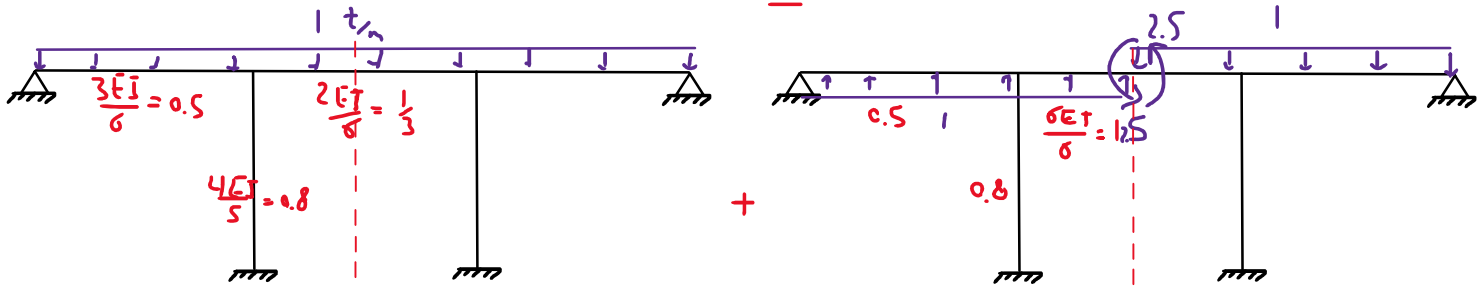

متقارن

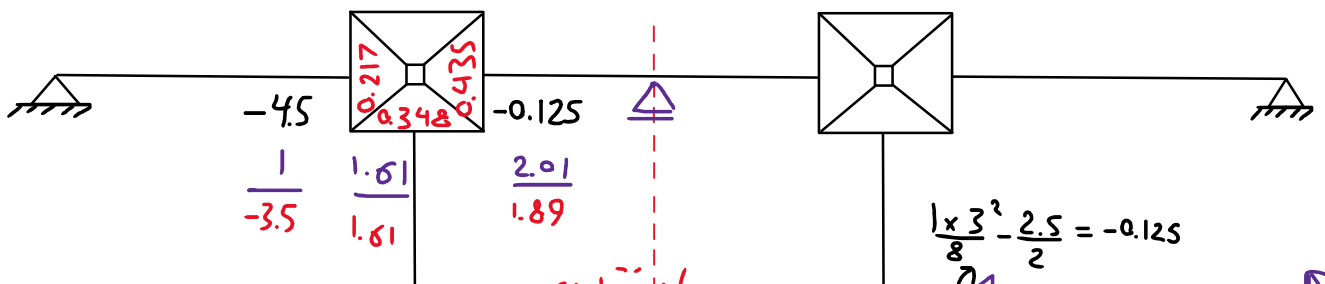

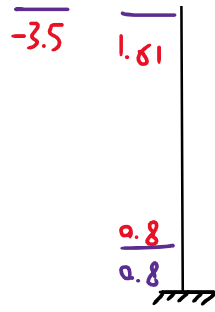

1.89  
بار منتعرج

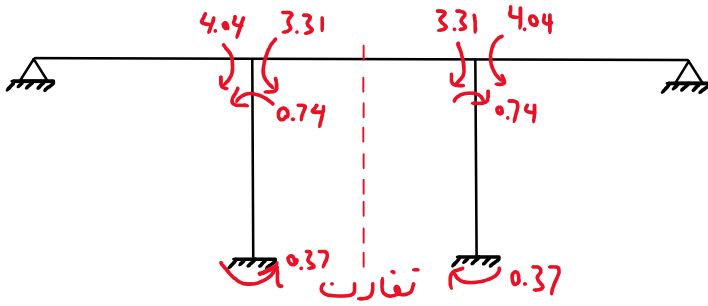
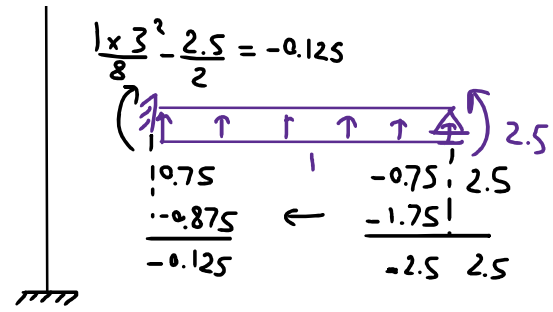

+

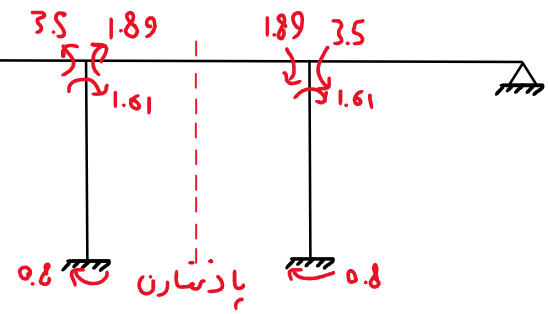

=

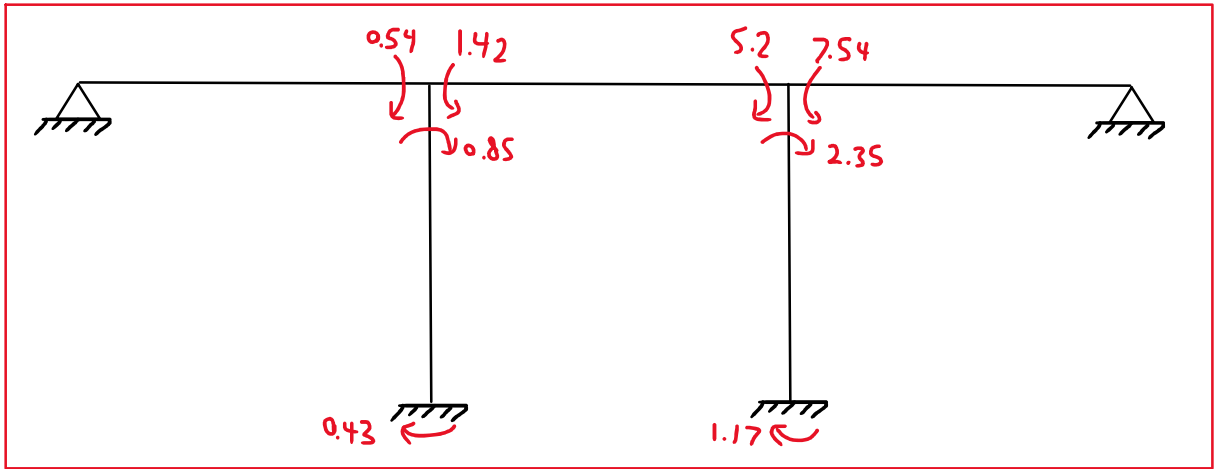

مثال: لنگرهای انتهای اعضا را بدست آورید.

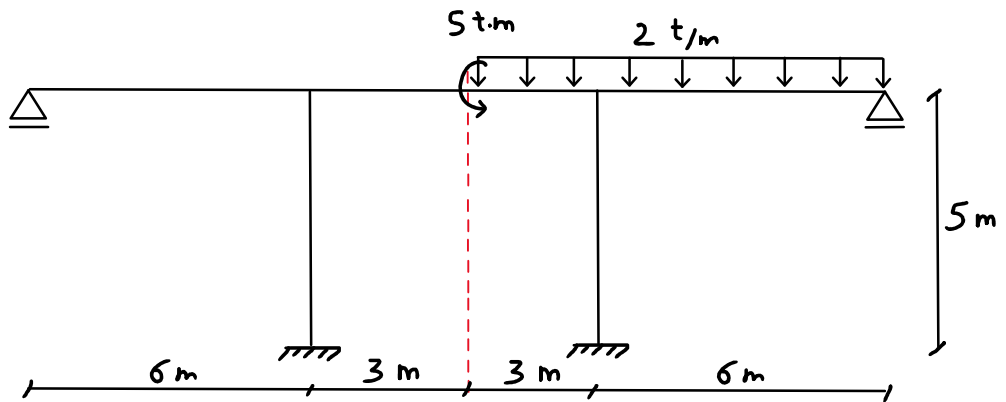

=

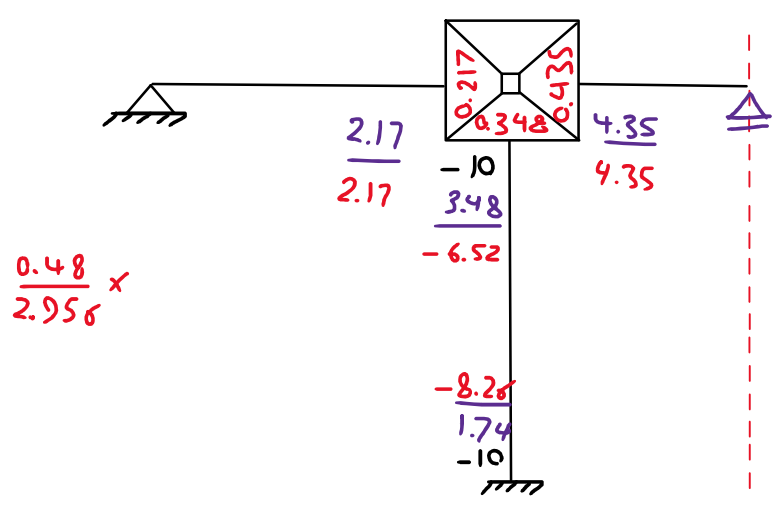
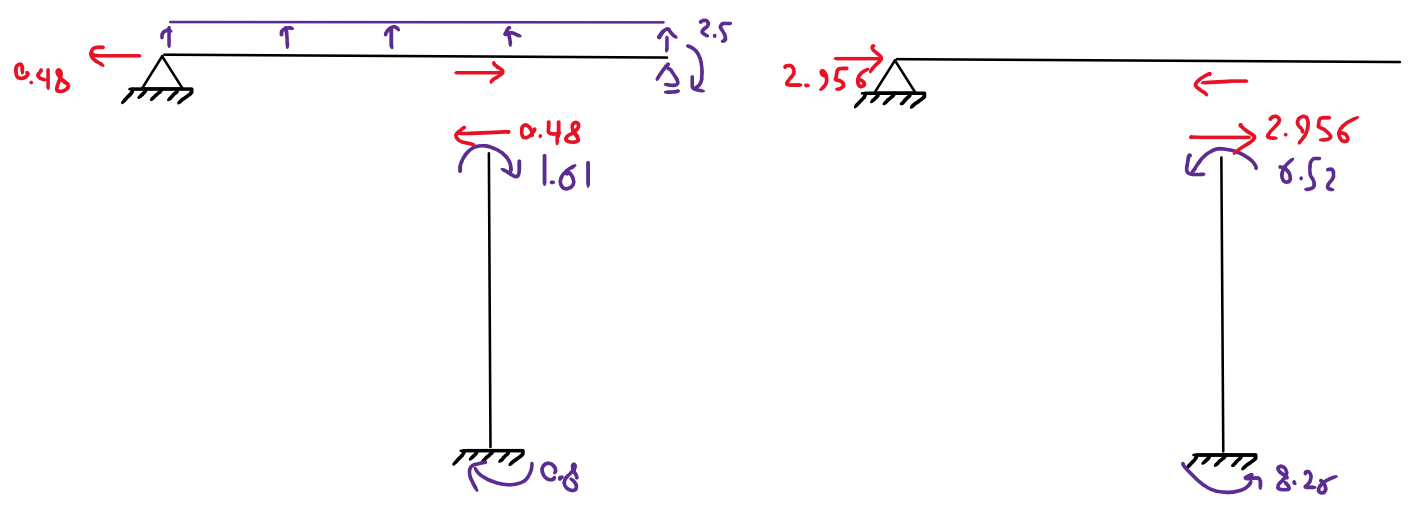
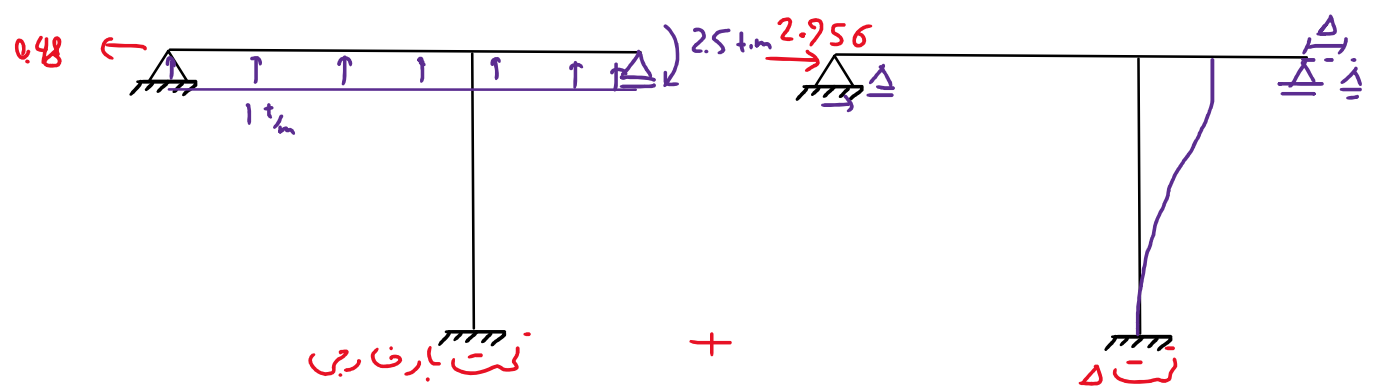
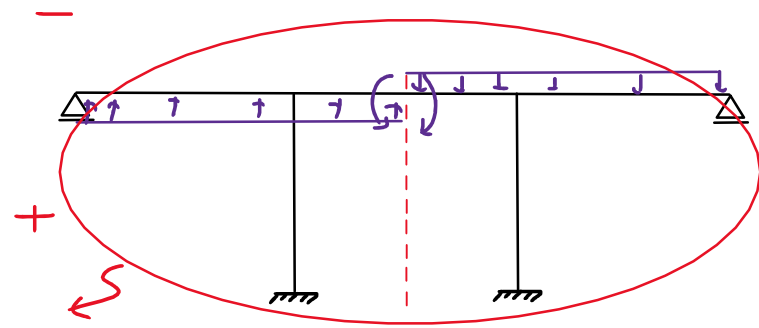
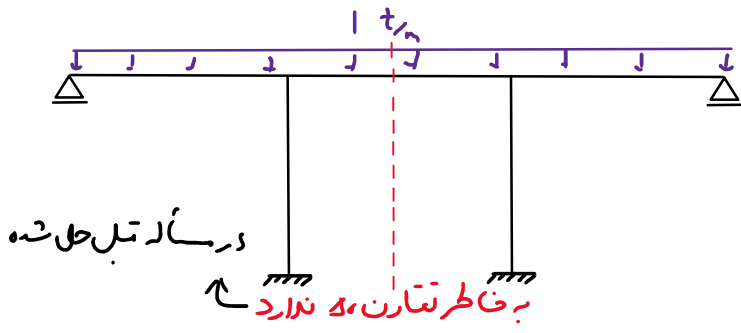

0.35 0.71 0.71 0.70

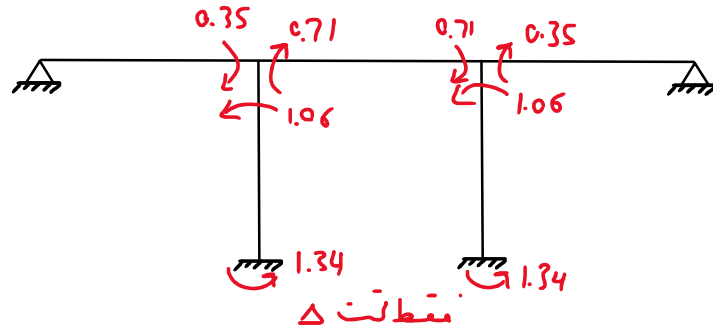

+

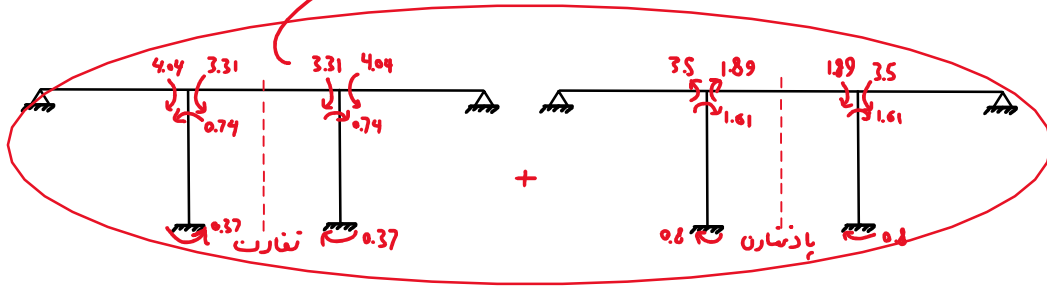
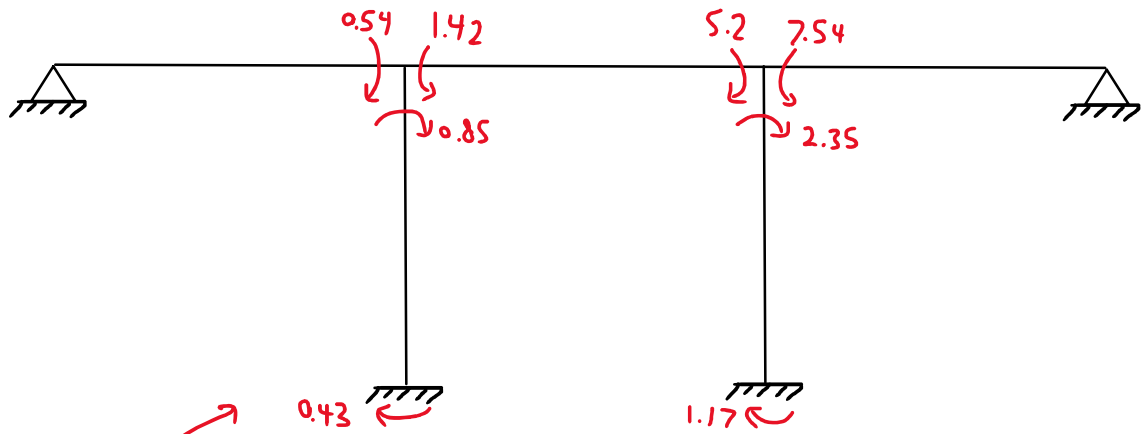

+

